**Road vehicles — Electrical disturbances
from conduction and coupling —**

Part 2:
**Electrical transient conduction along
supply lines only**

*Véhicules routiers — Perturbations électriques par conduction et par
couplage —*

*Partie 2: Transmission des perturbations électriques transitoires par
conduction uniquement le long des lignes d'alimentation*



PDF disclaimer

This PDF file may contain embedded typefaces. In accordance with Adobe's licensing policy, this file may be printed or viewed but shall not be edited unless the typefaces which are embedded are licensed to and installed on the computer performing the editing. In downloading this file, parties accept therein the responsibility of not infringing Adobe's licensing policy. The ISO Central Secretariat accepts no liability in this area.

Adobe is a trademark of Adobe Systems Incorporated.

Details of the software products used to create this PDF file can be found in the General Info relative to the file; the PDF-creation parameters were optimized for printing. Every care has been taken to ensure that the file is suitable for use by ISO member bodies. In the unlikely event that a problem relating to it is found, please inform the Central Secretariat at the address given below.

© ISO 2004

All rights reserved. Unless otherwise specified, no part of this publication may be reproduced or utilized in any form or by any means, electronic or mechanical, including photocopying and microfilm, without permission in writing from either ISO at the address below or ISO's member body in the country of the requester.

ISO copyright office
Case postale 56 • CH-1211 Geneva 20
Tel. + 41 22 749 01 11
Fax + 41 22 749 09 47
E-mail copyright@iso.org
Web www.iso.org

Published in Switzerland

Contents

Page

Foreword.....	iv
1 Scope.....	1
2 Normative references	1
3 Terms and definitions.....	1
4 Test procedure	1
4.1 General.....	1
4.2 Test temperature and test voltage	2
4.3 Voltage transient emissions test.....	2
4.4 Transient immunity test.....	4
5 Test instrument description and specifications	6
5.1 Artificial network.....	6
5.2 Shunt resistor R_S	6
5.3 Switch S	7
5.4 Power supply.....	8
5.5 Measurement instrumentation.....	8
5.5.1 Oscilloscope.....	8
5.5.2 Voltage probe	9
5.5.3 Waveform acquisition equipment	9
5.6 Test pulse generator for immunity testing	9
5.6.1 Test pulse 1	10
5.6.2 Test pulses 2a and 2b.....	11
5.6.3 Test pulses 3a and 3b.....	13
5.6.4 Test pulse 4	15
5.6.5 Test pulses 5a and 5b.....	16
Annex A (normative) Failure mode severity classification	18
Annex B (informative) General technique for improving device electromagnetic compatibility	22
Annex C (normative) Transient emissions evaluation — Voltage waveform.....	23
Annex D (normative) Test pulse generator verification procedure.....	26
Annex E (informative) Determination of pulse generator's energy capability	29
Annex F (informative) Origin of transients in road vehicle electrical systems	33

Foreword

ISO (the International Organization for Standardization) is a worldwide federation of national standards bodies (ISO member bodies). The work of preparing International Standards is normally carried out through ISO technical committees. Each member body interested in a subject for which a technical committee has been established has the right to be represented on that committee. International organizations, governmental and non-governmental, in liaison with ISO, also take part in the work. ISO collaborates closely with the International Electrotechnical Commission (IEC) on all matters of electrotechnical standardization.

International Standards are drafted in accordance with the rules given in the ISO/IEC Directives, Part 2.

The main task of technical committees is to prepare International Standards. Draft International Standards adopted by the technical committees are circulated to the member bodies for voting. Publication as an International Standard requires approval by at least 75 % of the member bodies casting a vote.

Attention is drawn to the possibility that some of the elements of this document may be the subject of patent rights. ISO shall not be held responsible for identifying any or all such patent rights.

ISO 7637-2 was prepared by Technical Committee ISO/TC 22, *Road vehicles*, Subcommittee SC 3, *Electrical and electronic equipment*.

This second edition of ISO 7637-2 cancels and replaces ISO 7637-1:1990 and ISO 7637-2:1990, of which it constitutes a technical revision. Note that ISO 7637-1:2002 cancelled and replaced ISO 7637-0:1990.

ISO 7637 consists of the following parts, under the general title *Road vehicles — Electrical disturbances from conduction and coupling*:

- *Part 1: Definitions and general considerations*
- *Part 2: Electrical transient conduction along supply lines only*
- *Part 3: Vehicles with nominal 12 V or 24 V supply voltage — Electrical transient transmission by capacitive and inductive coupling via lines other than supply lines*

Road vehicles — Electrical disturbances from conduction and coupling —

Part 2: Electrical transient conduction along supply lines only

1 Scope

This part of ISO 7637 specifies bench tests for testing the compatibility to conducted electrical transients of equipment installed on passenger cars and light commercial vehicles fitted with a 12 V electrical system or commercial vehicles fitted with a 24 V electrical system — for both injection and the measurement of transients. Failure mode severity classification for immunity to transients is also given. It is applicable to these types of road vehicle, independent of the propulsion system (e.g. spark ignition or diesel engine, or electric motor).

2 Normative references

The following referenced documents are indispensable for the application of this document. For dated references, only the edition cited applies. For undated references, the latest edition of the referenced document (including any amendments) applies.

ISO 7637-1:2002, *Road vehicles — Electrical disturbances from conduction and coupling — Part 1: Definitions and general considerations*

ISO 8854:1988, *Road vehicles — Alternators with regulators — Test methods and general requirements*

3 Terms and definitions

For the purposes of this document, the terms and definitions given in ISO 7637-1 apply.

4 Test procedure

4.1 General

These tests for measuring the transient emission on supply lines and the immunity of devices against such transients are called “bench tests”, made in the laboratory.

The methods, some of which require the use of the artificial network, will provide comparable results between laboratories. They will also give the basis for the development of devices and systems, and may be used during the production phase (see Annex B).

A bench test method for the evaluation of the immunity of a device against supply line transients may be performed by means of a test pulse generator; this may not cover all types of transients which can occur in a vehicle. Therefore, the test pulses described in 5.6 are characteristic of typical pulses.

In special cases, it could be necessary to apply additional test pulses. However, some pulses may be omitted if a device, depending on its function or its connection, is not influenced by comparable transients in the vehicle. It is the vehicle manufacturer's responsibility to define the test pulses required for a specific device.

Unless otherwise specified, a tolerance of $\pm 10\%$ applies to all variables used.

4.2 Test temperature and test voltage

The ambient temperature during the test shall be $(23 \pm 5)^\circ\text{C}$.

The test voltages shall be according to Table 1 unless other values are agreed upon by the users of this part of ISO 7637, in which case such values shall be documented in test reports.

Table 1 — Test voltages

Test voltage	12 V system V	24 V system V
U_A	$13,5 \pm 0,5$	27 ± 1
U_B	$12 \pm 0,2$	$24 \pm 0,4$

4.3 Voltage transient emissions test

This subclause specifies a test procedure for evaluating the automotive electrical and electronic components of the device under test (DUT), considered a potential source of conducted disturbances, for conducted emissions of transients along the battery-fed or switched supply lines.

Care shall be taken to ensure that the surrounding electromagnetic environment does not interfere with the measurement set-up.

Voltage transients from the disturbance source, the DUT, are measured using the artificial network to standardize the impedance loading on the DUT (see 5.1). The disturbance source is connected via the artificial network to the shunt resistor, R_s (see 5.2), the switch, S (see 5.3), and the power supply (see 5.4), as shown in Figure 1 a) or b).

All wiring connections between artificial network, switch, and the DUT shall be spaced (50^{+10}_0) mm above the metal ground plane.

The cable sizes shall be chosen in accordance with the real situation in the vehicle, i.e. the wiring shall be capable of handling the operating current of the DUT, and as agreed between vehicle manufacturer and supplier.

If no requirements are specified in the test plan, then the DUT shall be placed on a non-conductive material (50^{+10}_0) mm above the ground plane.

The disturbance voltage shall be measured as close to the DUT terminals as possible [see Figure 1 a) or b)], using a voltage probe (see 5.5.2) and an oscilloscope (see 5.5.1) or waveform acquisition equipment (see 5.5.3).

Repetitive transients shall be measured with the switch S closed. If the transient is caused by a supply disconnection, measurement shall be started at the moment of opening switch S.

For evaluation and values, see Annex C.

Dimensions in millimetres
Drawing not to scale

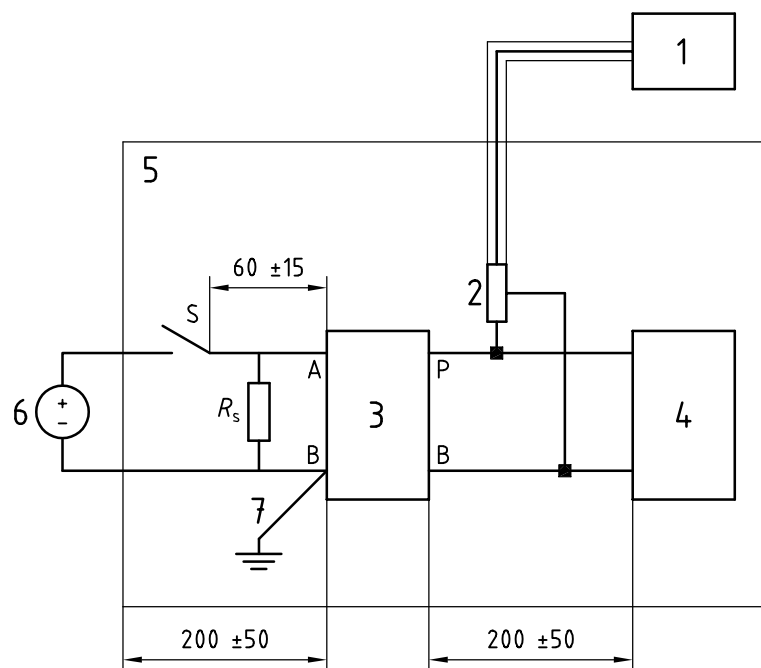

a) Slow pulses (millisecond range or slower)

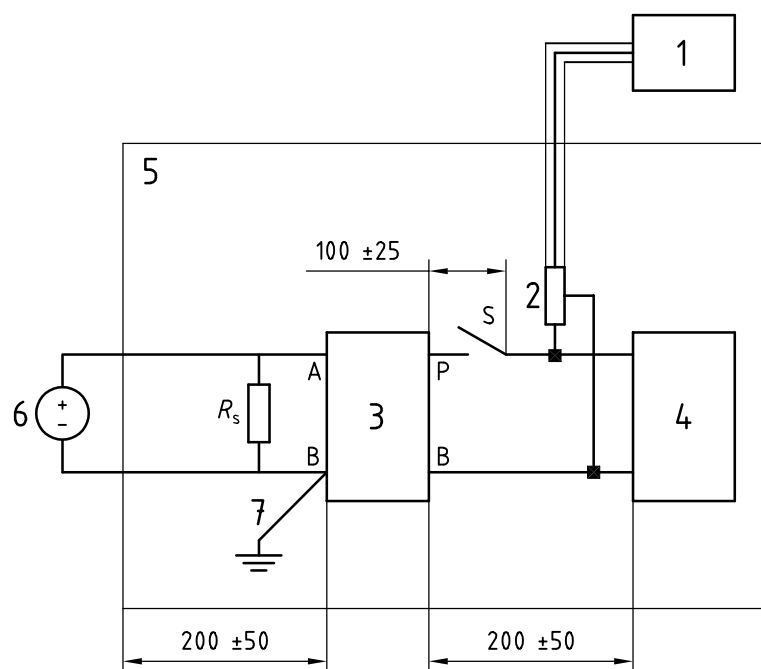

b) Fast pulses (nanosecond-to-microsecond range)

Key

- | | | | |
|---|----------------------------|---|------------------------------------|
| 1 | oscilloscope or equivalent | 5 | ground plane |
| 2 | voltage probe | 6 | power supply |
| 3 | artificial network | 7 | Ground connection; length < 100 mm |
| 4 | DUT (source of transient) | | |

NOTE For A, B, P, see Figure 3.

Figure 1 — Transient emission test set-up

DUT operating conditions of particular interest in the measurements are the turn on, the turn off, and the exercising of the various operating modes of the DUT. The exact operating conditions of the DUT shall be specified in the test plan.

The sampling rate and trigger level shall be selected to capture a waveform displaying the complete duration of the transient, with sufficient resolution to display the highest positive and negative portions of the transient.

Utilising the proper sampling rate and trigger level, the voltage amplitude shall be recorded by actuating the DUT according to the test plan. Other transient parameters, such as rise time, fall time and transient duration, may also be recorded. Unless otherwise specified, ten waveform acquisitions are required. Only those waveforms with the highest positive and negative amplitude (with their associated parameters) shall be recorded.

The measured transient shall be evaluated according to Annex C. All pertinent information and test results shall be reported. If required per the test plan, include transient evaluation results with respect to the performance objective as specified in the test plan.

4.4 Transient immunity test

The test set-up for transient immunity measurements of electrical/ electronic devices shall be as shown in Figure 2.

For test pulses 3a and 3b, the leads between the terminals of the test pulse generator and the DUT shall be laid out in a straight parallel line at a height of (50^{+10}_0) mm above the ground plane and shall have a length of $(0,5 \pm 0,1)$ m.

The test pulse generator (see 5.6) is set up to provide the specific pulse polarity, amplitude, duration and resistance with the DUT and optional resistance R_v disconnected [see Figure 2 a)]. The appropriate values are selected from Annex A. Next, the DUT is connected to the generator [see Figure 2 b)], while the oscilloscope is disconnected.

Depending on the real conditions, the function of the DUT may be evaluated during and/or after the application of the test pulses.

For correct generation of the required test pulses, it may be necessary to switch the power supply on and off. The switching can be performed by the test pulse generator if the power supply is integral to it.

One way to simulate the waveform of an alternator with centralized load dump suppression (see Figure 12), is to connect a suppression diode (or diode bridge) across the output terminals of the test pulse generator [see Figure 2 a) and b)]. Since a single diode will generally have part-to-part variation and may not be able to handle the large alternator currents, the use of a bridge arrangement [an example is shown in Figure 2 c)] is recommended. The same generator shall be used for test pulses 5a and 5b.

The suppression diodes and the suppressed voltage levels (clamping voltage) used by different car manufacturers are not standard. The supplier (parts manufacturers) must, therefore, obtain the diode and clamping voltage specification information from the manufacturer to be able to perform this test. The single diodes are added to the diode bridge as needed to provide the specified clamping voltage.

Dimensions in millimetres
Drawing not to scale

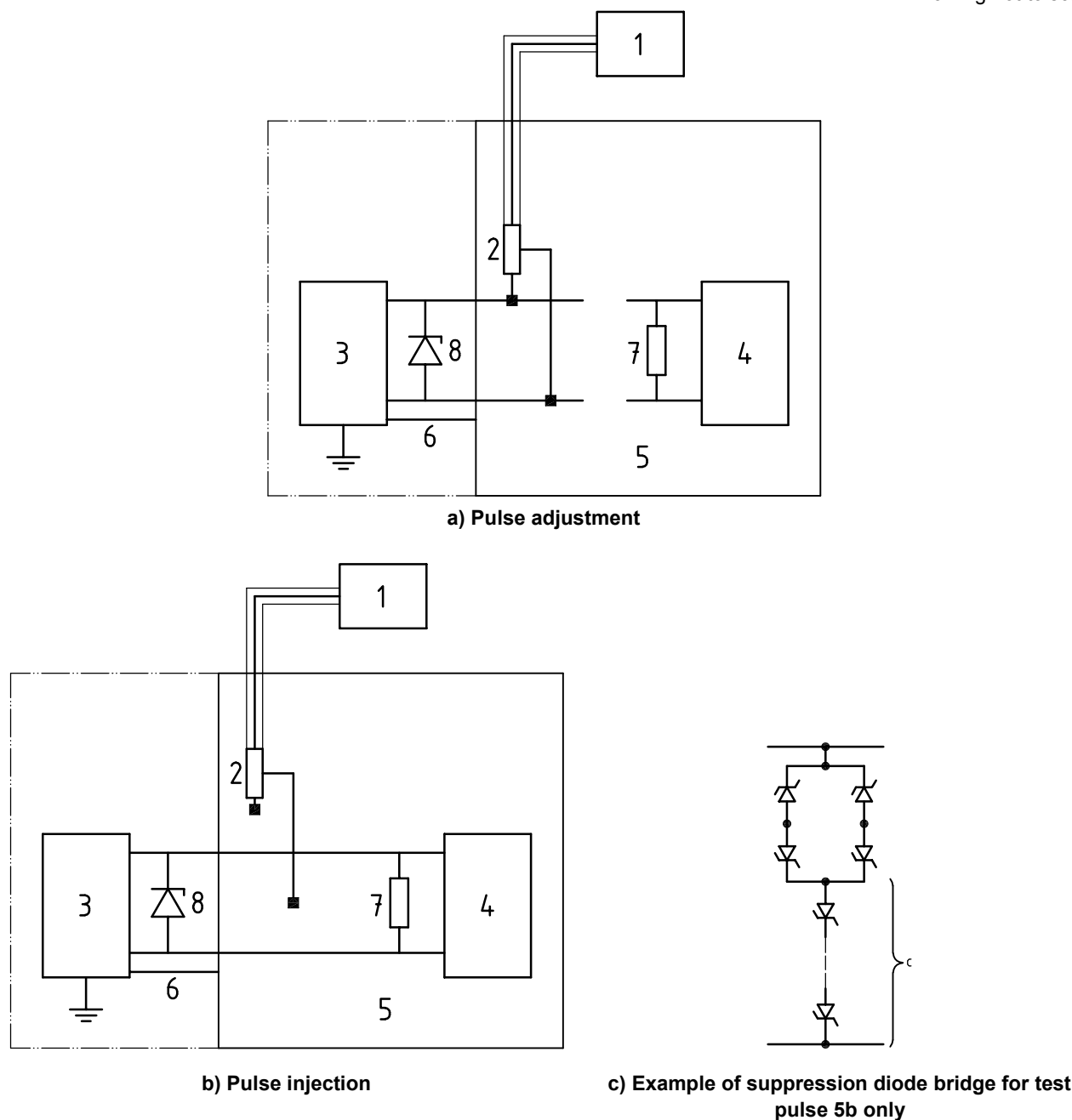

Key

- | | | | |
|---|--|---|---|
| 1 | oscilloscope or equivalent | 5 | ground plane |
| 2 | voltage probe | 6 | Ground connection (maximum length for test pulse 3: 100 mm) |
| 3 | test pulse generator with internal power supply resistance R_i | 7 | optional resistor (R_v) ^a |
| 4 | DUT | 8 | optional diode bridge ^b |

^a For simulation of vehicle system loading for load dump test pulses 5a and 5b only. If used, the value of R_v shall be specified in the test plan (typical value 0,7 Ω to 40 Ω).

^b For simulation of load dump waveform for alternator with centralized load dump suppression for pulse 5b only [see Figure 2 c)].

^c Add forward biased diodes as required to achieve max. open-circuit (suppressed) voltage.

Figure 2 — Transient immunity test set-up

5 Test instrument description and specifications

5.1 Artificial network

The artificial network is used as a reference standard in the laboratory in place of the impedance of the vehicle wiring harness, in order to determine the behaviour of equipment and electrical and electronic devices. An example of a schematic diagram is shown in Figure 3.

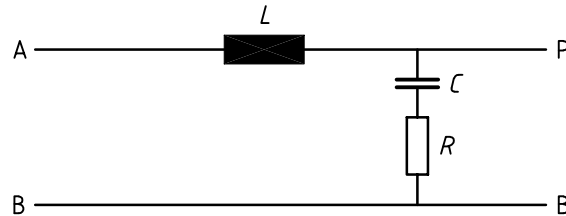

Key

- A power supply terminal
- B common terminal (may be grounded)
- C capacitor
- L inductance
- P terminal for DUT
- R resistor

Main characteristics of the components:

$$L = 5 \mu\text{H (air-core winding)}$$

Internal resistance between terminals P and A: $< 5 \text{ m}\Omega$

$C = 0,1 \mu\text{F}$ for working voltages of 200 V a.c. and 1 500 V d.c.

$$R = 50 \Omega$$

Figure 3 — Example schematic diagram of artificial network

The artificial network shall be able to withstand a continuous load corresponding to the requirements of the DUT.

The resulting values of impedance $|Z_{PB}|$, measured between the terminals P and B while terminals A and B are short-circuited, are given in Figure 4 as a function of frequency assuming ideal electric components. In reality, the impedance of an artificial network shall not deviate more than 10 % from the curve given in Figure 4.

If the artificial network has a metal enclosure, it shall be placed flat on the ground plane and the ground terminal on the power source end shall be connected to the ground plane as shown in Figures 1 a) and b).

5.2 Shunt resistor R_S

The shunt resistor R_S (see Figure 1) simulates the d.c. resistance of other vehicle devices which are connected in parallel to the DUT and are not disconnected from it by the ignition switch. R_S is selected to correspond to the resistance measured on the wiring harness between the disconnected ignition switch terminal and ground, with the switch off, and shall be specified by the vehicle manufacturer. In the absence of any specification, a value of $R_S = 40 \Omega$ shall be used. If a wire-wound resistor is used, the winding shall be bifilar (i.e. with a minimum reactive component).

To simulate the worst-case condition, R_S may be switched off.

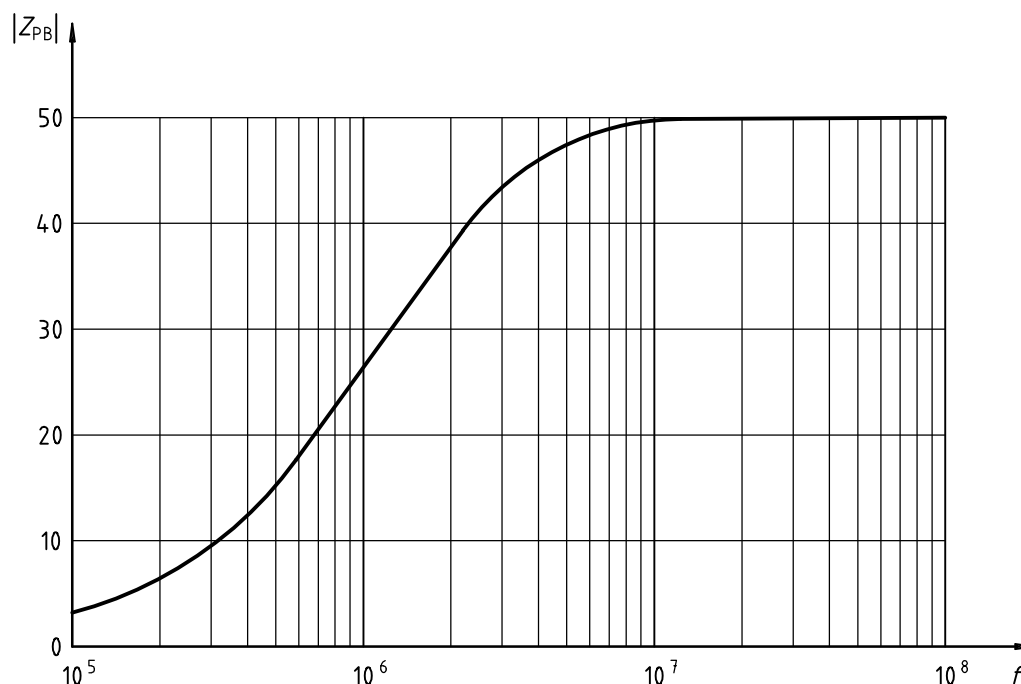
**Key**

$ Z_{PB} $	impedance (Ω)
f	frequency (Hz)

Figure 4 — Impedance $|Z_{PB}|$ as function of frequency from 100 kHz to 100 MHz (A, B short-circuited)

5.3 Switch S

The switching device S can be located on either side of the artificial network as shown in Figure 1 depending on the actual application. For the measurement of transients ($t_d \approx \mu\text{s}$ range), the switch on the DUT side of the artificial network must be actuated.

During the test, only one of the switching devices shown in Figure 1 shall be actuated (the contact of the other switching device shall be closed). The selection of the switching device shall be specified in the test plan prior to the test and documented in the test report.

As S significantly influences the disturbance transient characteristics, the recommended switching devices are described below:

- a) For the measurement of high voltage transients (with amplitudes over 400 V), the switching device is recommended to be a standard production switch that is used in the vehicle with the DUT. If such a device is not available, an automotive relay with the following characteristics shall be used:
 - contact rating, $I = 30$ A, continuous, resistive load;
 - high purity silver contact material;
 - no suppression across relay contact;
 - single/double position contact electrically insulated from the coil circuit;
 - coil with transient suppression.

The switching relay shall be replaced if significant contact degradation occurs.

- b) An unequivocal assessment of the disturbance is only possible if a switch with reproducible properties is used. For this purpose, an electronic switch is proposed. It is probable that amplitudes of disturbance are higher than those normally encountered with conventional switches (arcing). This shall be taken into account when evaluating test results. The electronic switch is very appropriate for controlling the function of suppressors used. For the measurement of lower voltage transients (with amplitudes less than 400 V), such as those produced by sources with transient suppressions, an electronic switch with the following characteristics should be used:
- maximum voltage, $U_{\max} = 400$ V at 25 A;
 - maximum current, $I_{\max} = 25$ A continuously, 100 A for $\Delta t \leq 1$ s;
 - voltage drop, $\Delta U \leq 1$ V at 25 A;
 - test voltages, $U_{A1} = 13,5$ V, $U_{A2} = 27$ V;
 - switching time, $\Delta t_s = 300$ ns ± 20 % with DUT;
 - $R = 0,6$ Ω , $L = 50$ μ H (1 kHz);
 - shunt resistor $R_s = 10$ Ω , 20 Ω , 40 Ω , and connection for external resistors;
 - trigger: internal and external;
 - voltage probe: 1: 100.

The switch shall withstand short-circuiting.

An artificial network according to 5.1 and Figures 3 and 4 shall be implemented, but it shall be possible to switch it off (50 Ω artificial network is defined up to 100 MHz).

5.4 Power supply

The continuous supply source shall have an internal resistance R_i of less than 0,01 Ω d.c. and an internal impedance $Z_i = R_i$ for frequencies less than 400 Hz. The output voltage shall not deviate more than 1 V from 0 to maximum load (including inrush current) and shall recover 63 % of its maximum excursion within 100 μ s. The superimposed ripple voltage, U_r , shall not exceed 0,2 V peak-to-peak and shall have a minimum frequency of 400 Hz.

If a standard power supply (with sufficient current capacity) is used to simulate the battery, it is important that the low internal impedance of the battery be also simulated.

When a battery is used, a charging source may be needed to achieve the specified reference levels (13,5 V and 27 V, respectively).

5.5 Measurement instrumentation

5.5.1 Oscilloscope

The use of a digitizing oscilloscope (minimum single sweep sampling rate of 2 GHz/s and 400 MHz bandwidth with input sensitivity: at least 5 mV/div.) is preferred. If a digitizing oscilloscope is not available, an analog storage oscilloscope may be used, which shall have the following minimum specifications:

- bandwidth d.c. to at least 400 MHz;
- writing speed of at least 100 cm/ μ s;
- input sensitivity of at least 5 mV/division.

The recording may be made with an oscilloscope camera or any other appropriate recording device.

5.5.2 Voltage probe

Characteristics of the voltage probe are

- attenuation of 100/1,
- maximum input voltage of at least 1 kV,
- input impedance Z and capacitance C according to Table 2 ;
- maximum probe cable length of 3 m;
- maximum probe ground length of 0,13 m.

The lengths will influence the measurement results and shall be stated in the test report.

Table 2 — Voltage probe parameters

f MHz	Z k Ω	C pF
1	> 40	< 4
10	> 4	< 4
100	> 0,4	< 4

5.5.3 Waveform acquisition equipment

Equipment that is capable of acquiring fast rise time transient waveforms may be used instead of an oscilloscope.

5.6 Test pulse generator for immunity testing

The test pulse generator shall be capable of producing the open circuit test pulses according to 5.6.1 to 5.6.5 at the maximum value of $|U_s|$. Moreover, U_s shall be adjustable within the limits given in Tables 3 to 9.

Peak voltage U_s shall be adjusted to the test levels specified in Annex A with a tolerance of $\left(\begin{smallmatrix} +10 \\ 0 \end{smallmatrix} \right) \%$. The timing (t) tolerances and internal resistance (R_i) tolerance shall be $\pm 20 \%$, unless otherwise specified.

A verification procedure for the generator performance and tolerances is given in Annex D.

Recommended values for the evaluation of immunity of devices are given in Annex A.

5.6.1 Test pulse 1

This test is a simulation of transients due to supply disconnection from inductive loads. It is applicable to DUTs which, as used in the vehicle, remain connected directly in parallel with an inductive load (see Annex F).

The pulse shape is given in Figure 5. See Table 3 for the corresponding parameters.

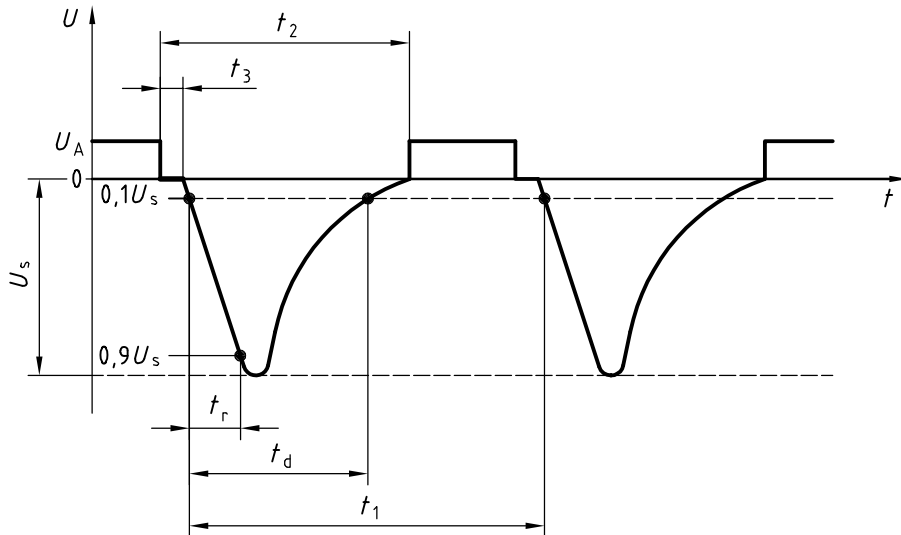

Figure 5 — Test pulse 1

Table 3 — Parameters for test pulse 1

Parameter	12 V system	24 V system
U_s	-75 V to -100 V	-450 V to -600 V
R_i	10 Ω	50 Ω
t_d	2 ms	1 ms
t_r	$1_{-0,5}^0 \mu\text{s}$	$3_{-1,5}^0 \mu\text{s}$
t_1^a	0,5 s to 5 s	
t_2	200 ms	
t_3^b	< 100 μs	

^a t_1 shall be chosen such that the DUT is correctly initialized before the application of the next pulse.

^b t_3 is the smallest possible time necessary between the disconnection of the supply source and the application of the pulse.

5.6.2 Test pulses 2a and 2b

Pulse 2a simulates transients due to sudden interruption of currents in a device connected in parallel with the DUT due to the inductance of the wiring harness (see Annex F).

Pulse 2b simulates transients from d.c. motors acting as generators after the ignition is switched off (see Annex F).

The pulse shapes are given in Figures 6 and 7; for the parameters, see Tables 4 and 5, respectively.

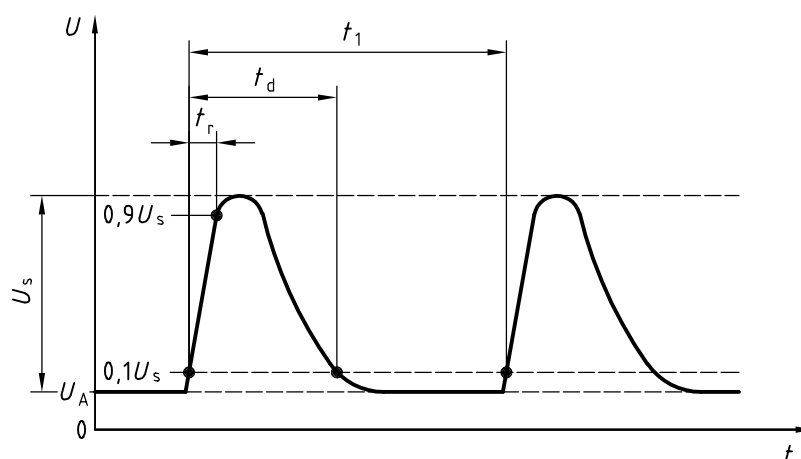

Figure 6 — Test pulse 2a

Table 4 — Parameters for test pulse 2a

Parameter	12 V system	24 V system
U_s	+ 37 V to + 50 V	
R_i	2 Ω	
t_d	0,05 ms	
t_r	$\begin{pmatrix} 1 & 0 \\ & -0,5 \end{pmatrix} \mu\text{s}$	
t_1^a	0,2 s to 5 s	

^a The repetition time t_1 can be short, depending on the switching. The use of a short repetition time reduces the test time.

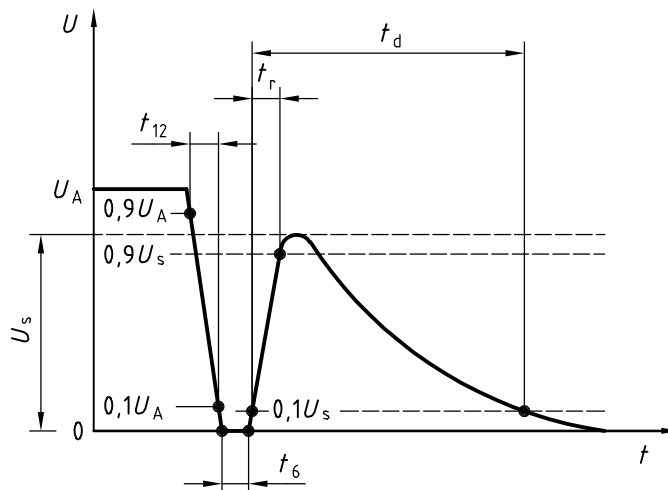

Figure 7 — Test pulse 2b

Table 5 — Parameters for test pulse 2b

Parameter	12 V system	24 V system
U_s	10 V	20 V
R_i	0 Ω to 0,05 Ω	
t_d	0,2 s to 2 s	
t_{12}	1 ms \pm 0,5 ms	
t_r	1 ms \pm 0,5 ms	
t_6	1 ms \pm 0,5 ms	

5.6.3 Test pulses 3a and 3b

These test pulses are a simulation of transients which occur as a result of the switching processes. The characteristics of these transients are influenced by distributed capacitance and inductance of the wiring harness (see Annex F).

The pulse shapes for these test pulses are given in Figures 8 and 9; for the parameters, see Tables 6 and 7, respectively.

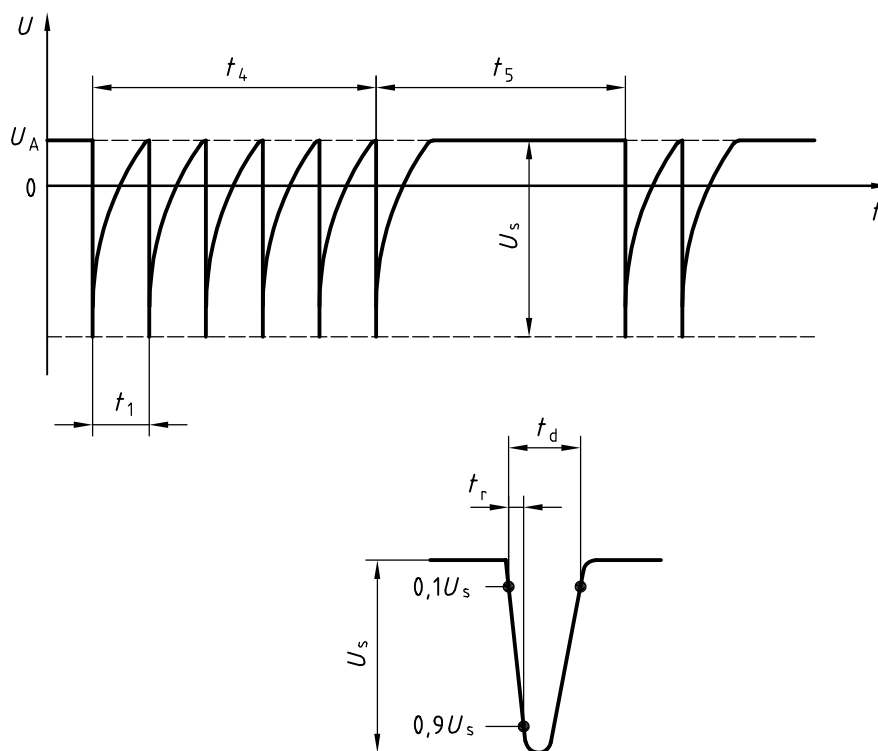

Figure 8 — Test pulse 3a

Table 6 — Parameters for test pulse 3a

Parameter	12 V system	24 V system
U_s	- 112 V to - 150 V	- 150 V to - 200 V
R_i	50 Ω	
t_d	$(0,1^{+0,1}_0)$ μ s	
t_r	5 ns \pm 1,5 ns	
t_1	100 μ s	
t_4	10 ms	
t_5	90 ms	

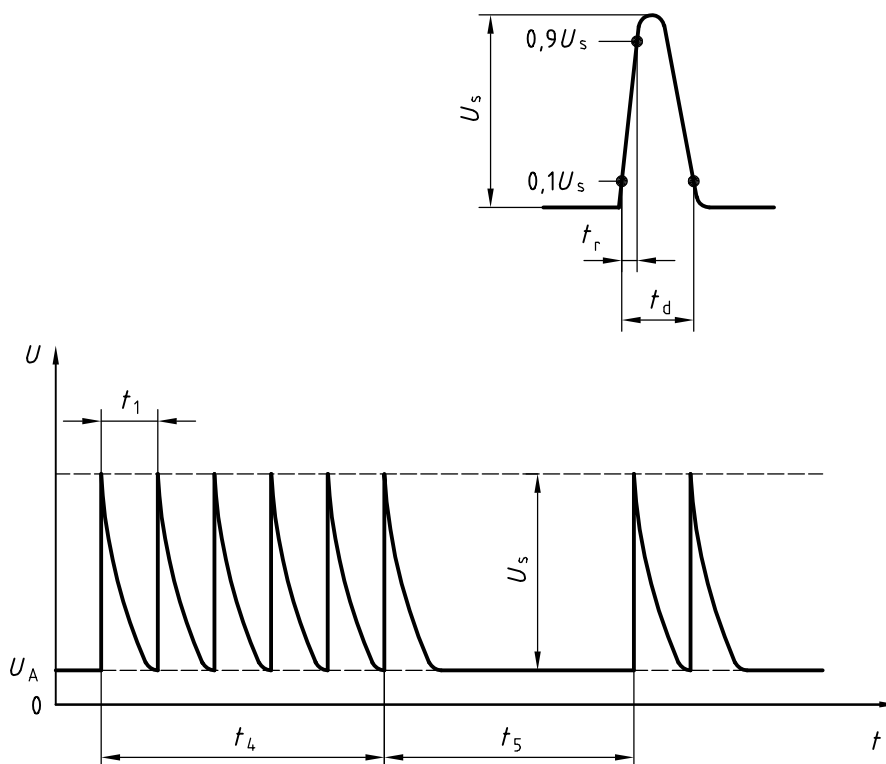

Figure 9 — Test pulse 3b

Table 7 — Parameters for test pulse 3b

Parameter	12 V system	24 V system
U_s	+ 75 V to + 100 V	+ 150 V to + 200 V
R_i	50 Ω	
t_d	$(0,1^{+0,1}_0) \mu\text{s}$	
t_r	5 ns \pm 1,5 ns	
t_1	100 μs	
t_4	10 ms	
t_5	90 ms	

5.6.4 Test pulse 4

This pulse simulates supply voltage reduction caused by energizing the starter-motor circuits of internal combustion engines, excluding spikes associated with starting (see Annex F).

The pulse shape and parameters are given in Figure 10 and Table 8.

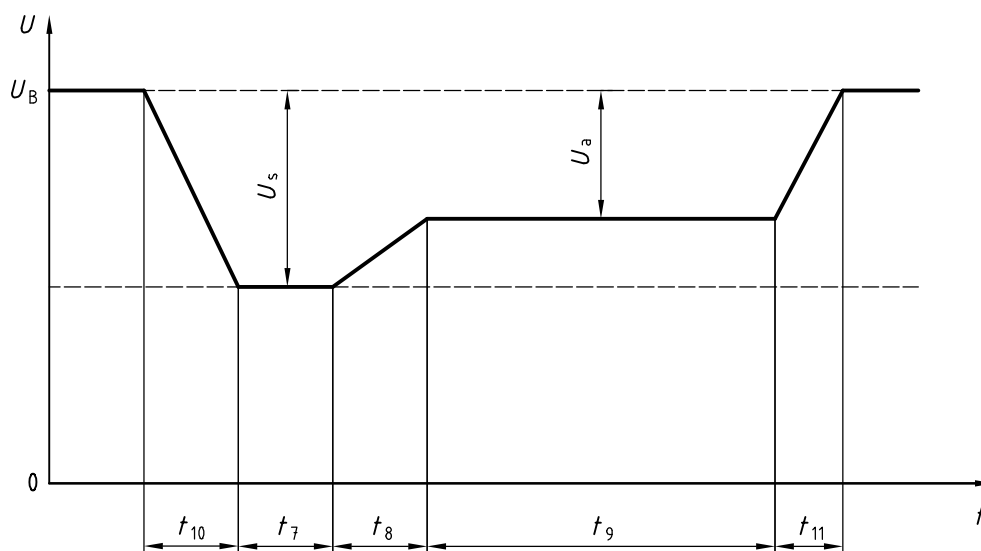

Figure 10 — Test pulse 4

Table 8 — Parameters for test pulse 4

Parameter	12 V system	24 V system
U_s	- 6 V to - 7 V	- 12 V to - 16 V
U_a	- 2,5 V to - 6 V with $ U_a \leq U_s $	- 5 V to - 12 V with $ U_a \leq U_s $
R_i	0 Ω to 0,02 Ω	
t_7	15 ms to 40 ms ^a	50 ms to 100 ms ^a
t_8	≤ 50 ms	
t_9	0,5 s to 20 s ^a	
t_{10}	5 ms	10 ms
t_{11}	5 ms to 100 ms ^b	10 ms to 100 ms ^c

^a The value used should be agreed between the vehicle manufacturer and the equipment supplier to suit the proposed application.

^b $t_{11} = 5$ ms is typical of the case when engine starts at the end of the cranking period, while $t_{11} = 100$ ms is typical of the case when the engine does not start.

^c $t_{11} = 10$ ms is typical of the case when engine starts at the end of the cranking period, while $t_{11} = 100$ ms is typical of the case when the engine does not start.

5.6.5 Test pulses 5a and 5b

This test is a simulation of load dump transient, occurring in the event of a discharged battery being disconnected while the alternator is generating charging current and with other loads remaining on the alternator circuit at this moment; the load dump amplitude depends on the alternator speed and on the level of the alternator field excitation at the moment the battery is disconnected. The load dump pulse duration depends essentially on the time constant of the field excitation circuit and on the pulse amplitude (see Annex F). In most new alternators, the load dump amplitude is suppressed (clamped) by the addition of the limiting diodes.

Load dump may occur on account of a battery being disconnected as a result of cable corrosion, poor connection or of intentional disconnection with the engine running.

The pulse shape and parameters for an alternator with no centralized load dump suppression (pulse 5a) are given in Figure 11 and Table 9. The pulse shape and parameters for an alternator with centralized load dump suppression (pulse 5b) are given in Figure 12 and Table 10.

The decreasing portion of the pulse follows an exponential curve which would theoretically decrease to 0 V, but is interrupted at U_A .

The following general considerations of the dynamic behaviour of alternators during load dump apply.

- a) The internal resistance of an alternator, in the case of load dump, is mainly a function of alternator rotational speed and excitation current.
- b) The internal resistance R_i of the load dump test pulse generator shall be obtained from the following relationship:

$$R_i = \frac{10 \times U_{\text{nom}} \times N_{\text{act}}}{0,8 \times I_{\text{rated}} \times 12\,000 \text{ min}^{-1}}$$

where

U_{nom} is the specified voltage of the alternator;

I_{rated} is the specified current at an alternator speed of 6 000 min⁻¹ (as given in ISO 8854);

N_{act} is the actual alternator speed, in reciprocal minutes.

- c) The pulse is determined by the peak voltage U_s , the clamped voltage U_s^* , the internal resistance R_i , and the pulse duration t_d . In all cases, small values of U_s are correlated with small values of R_i and t_d , and high values of U_s with high values of R_i and t_d .

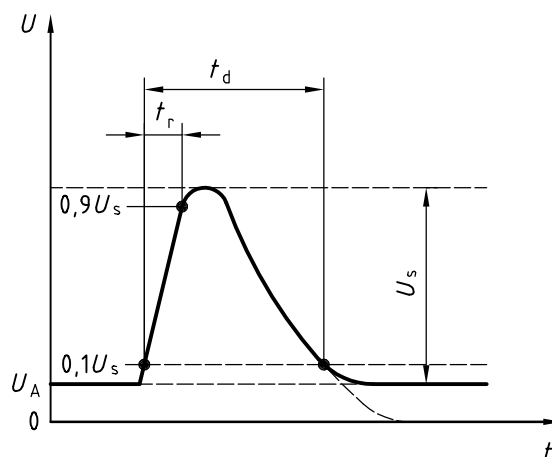
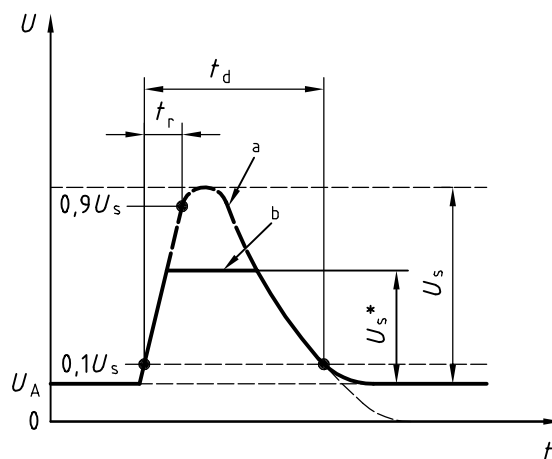

Figure 11 — Test pulse 5a

Table 9 — Parameters for test pulse 5a

Parameter	12 V system	24 V system
U_s	65 V to 87 V	123 V to 174 V
R_i	0,5 Ω to 4 Ω	1 Ω to 8 Ω
t_d	40 ms to 400 ms	100 ms to 350 ms
t_r	$\left(10 \begin{smallmatrix} 0 \\ -5 \end{smallmatrix}\right)$ ms	



- a Unsuppressed.
b Suppressed.

Figure 12 — Test pulse 5b

Table 10 — Parameters for test pulse 5b

Parameter	12 V system	24 V system
U_s	65 V to 87 V	123 V to 174 V
U_s^*	As specified by customer	
t_d	Same as unsuppressed value	

Annex A (normative)

Failure mode severity classification

A.1 Purpose

The purpose of this annex is to provide a method of classifying the functional status of automotive electronic devices upon application of the test conditions specified in this part of ISO 7637. The process described applies only to the bench testing of automotive electronic devices using the methods given in this part of ISO 7637.

A.2 General

Components or systems shall only be tested under those conditions which represent the environments to which the device would actually be subjected, i.e. as used in a vehicle. This will help ensure sound technical and economically optimized designs for susceptible systems.

This annex is not intended to be a product specification and cannot function as one. Nevertheless, applying the concepts of this part of ISO 7637 and with careful application and agreement between vehicle manufacturer and equipment supplier, it should be possible to develop a document giving the functional status requirements for a specific device. This could then, in fact, be a statement of how a particular device could be expected to perform under the influence of the specified disturbance transients (see A.7).

A.3 Essential elements of a failure mode classification system

There are three elements required to describe a general failure mode severity classification:

- a) functional status classification — operational status of a device during and after exposure to an electromagnetic environment;
- b) test pulse and method — reference to the representative test pulse applied to the DUT and test method (this information is contained in the main body of this part of ISO 7637);
- c) test pulse severity — specification of the severity level of essential pulse parameters.

A.4 Classification of functional status

All classifications are for the total device/system functional status.

Class A: all functions of a device/system perform as designed during and after exposure to disturbance.

Class B: all functions of a device/system perform as designed during exposure. However, one or more of them can go beyond specified tolerance. All functions return automatically to within normal limits after exposure is removed. Memory functions shall remain class A.

Class C: one or more functions of a device/system do not perform as designed during exposure but return automatically to normal operation after exposure is removed.

Class D: one or more functions of a device/system do not perform as designed during exposure and do not return to normal operation until exposure is removed and the device/system is reset by simple “operator/use” action.

Class E: one or more functions of a device/system do not perform as designed during and after exposure and cannot be returned to proper operation without repairing or replacing the device/system.

NOTE The word “function” in this context refers only to the function performed by the electronic system.

A.5 Classification of test pulse severity

The suggested minimum and maximum severity levels are given in columns III and IV of Tables A.1 and A.2. A selected level and test time for testing at or in between these values may be chosen according to the agreement between vehicle manufacturer and equipment supplier. In cases where no specific values are defined, levels from columns III to IV of the two tables should be selected.

Table A.1 — Suggested test levels for 12 V system

Test pulse ^a	Selected test level ^b	Test level, U_s^c V				Min. number of pulses or test time ^f	Burst cycle/pulse repetition time	
		I	II	III min.	IV max.		min.	max.
1		g	g	– 75	– 100	5 000 pulses	0,5 s	5 s
2a		g	g	+ 37	+ 50	5 000 pulses	0,2 s	5 s
2b		g	g	+ 10	+ 10	10 pulses	0,5 s	5 s
3a		g	g	– 112	– 150	1 h	90 ms	100 ms
3b		g	g	+ 75	+ 100	1 h	90 ms	100 ms
4		g	g	– 6	– 7	1 pulse	d	d
5 ^e		g	g	+ 65	+ 87	1 pulse	d	d

^a Test pulses as in 5.6.

^b Values agreed to between vehicle manufacturer and equipment supplier.

^c The amplitudes are the values of U_s as defined for each test pulse in 5.6.

^d Since the minimum number of test pulses is 1, no pulse cycle time is given. When several pulses are to be applied, a minimum delay of 1 min between pulses shall be allowed.

^e See 5.6.5 c). The test levels reflect the situation of load dump at generator rated speed. If a central load dump protection is used, apply test pulse 5b as defined in Figure 12 and use the values in table 10.

^f The number of pulses/time is for durability test purposes.

^g The former levels I and II were deleted because they do not ensure sufficient immunity in road vehicles.

Table A.2 — Suggested test levels for 24 V system

Test pulse ^a	Selected test level ^b	Test level, U_s^c V				Min. number of pulses or test time ^f	Burst cycle/pulse repetition time	
		I	II	III min.	IV max.		min.	max.
1		g	g	- 450	- 600	5 000 pulses	0,5 s	5 s
2a		g	g	+ 37	+ 50	5 000 pulses	0,2 s	5 s
2b		g	g	+ 20	+ 20	10 pulses	0,5 s	5 s
3a		g	g	- 150	- 200	1 h	90 ms	100 ms
3b		g	g	+ 150	+ 200	1 h	90 ms	100 ms
4		g	g	- 12	- 16	1 pulse	d	d
5 ^e		g	g	+ 123	+ 173	1 pulse	d	d

- ^a Test pulses as in 5.6.
- ^b Values agreed to between vehicle manufacturer and equipment supplier.
- ^c The amplitudes are the values of U_s as defined for each test pulse in 5.6.
- ^d Since the minimum number of test pulses is 1, no pulse cycle time is given. When several pulses are to be applied, a minimum delay of 1 min between pulses shall be allowed.
- ^e See 5.6.5 c). The test levels reflect the situation of load dump at generator rated speed. If a central load dump protection is used, apply test pulse 5b as defined in Figure 12 and use the values in Table 10.
- ^f The number of pulses/time is for durability test purposes.
- ^g The former levels I and II were deleted because they do not ensure sufficient immunity in road vehicles.

A.6 Allocation of functional status to test pulse severity

Manufacturer and user shall specify the classification of functional status (see A.4) and of test pulse severity (see A.5), bearing in mind the specific application of the device.

Test pulses which do not reach the specific device under real conditions, i.e. when the device is operated in a vehicle, may be omitted.

A functional impairment of class C may be acceptable for devices which need not work during the occurrence of distinct pulses (e.g. flashers during cranking).

A functional impairment of class D may be acceptable for devices the malfunction of which does not cause customer annoyance or inconvenience.

A functional impairment of class E is defined primarily for test report purposes and would not normally be acceptable for a device unless under special circumstances.

A.7 Presentation of results

The following examples illustrate how the failure mode severity classification can be used to characterize a device when applying this part of ISO 7637.

Example 1

This is an example of how a device supplier might characterize the performance of his device for sales or engineering purposes. Table A.3 shows the characteristics of the device for all applicable test pulses and the functional status after exposure to all test severity classification.

Table A.3 — Example 1 — 12 V and 24 V systems

Test pulse	Functional status (see A.4) according to test level				Remark
	I	II	III	IV	
1	Not applicable				Device connected with battery positive
2a	Not applicable				Device connected with battery positive
2b	Not applicable				Device connected with battery positive
3a	—	—	A	C	—
3 b	—	—	B	C	—
4, etc.	—	—	C	D	Device need not be operative during cranking, etc.

NOTE In testing the device to increasing test pulse severity, care would have to be taken to avoid possible cumulative effects from previous test applications if the same device were used for all tests.

Example 2

This is an example of how a customer might characterize the minimum requirements for a particular device. Tables A.4 and A.5 constitute a possible product specification to be used for engineering and purchasing requirements.

Table A.4 — Example 2 —12 V system

Test pulse	Test level V	Functional status in accordance with A.4	Minimum number of pulses or test time	Remark
1	– 75	C	5 000 pulses	Durability test
2a	+ 50	A	5 000 pulses	Durability test
2b	+ 10	A	10 pulses	Functional test
3a	– 112	C	1 h	Durability test
3b	+ 75	C	3 h	Durability test
4	—	—	—	Not applicable
5	—	—	—	Not applicable

Table A.5 — Example 2 — 24 V system

Test pulse	Test level V	Functional status in accordance with A.4	Minimum number of pulses or test time	Remark
1	– 150 to – 450	A	5 000 pulses	Durability test
2a	+ 50	A	5 000 pulses	Durability test
2b	+ 20	A	10 pulses	Functional test
3a	– 35 to – 150	C	1 h	Durability test
3b	+ 35 to + 150	C	3 h	Durability test
4	—	—	—	Not applicable
5	—	—	—	Not applicable

Annex B (informative)

General technique for improving device electromagnetic compatibility

B.1 Limiting emissions from disturbance sources

The most effective way to suppress emissions is at the source.

Disturbance transients should be suppressed internal to, or at the terminals of, the disturbance source by means of diodes, zener diodes, varistors, damping resistors, capacitors, suppression filters, etc.

If it is not possible to suppress transients internally or at the terminals, the suppression unit shall be placed as close to the source as possible.

The use of a zener diode, varistor and other components at the main network terminals may give sufficient protection for susceptible equipment if no disconnecting switch is located between the transient source and the suppressor.

B.2 Equipment immunity improvement

The immunity of devices can be improved by using diodes, zener diodes, varistors, capacitors, suppression filters, damping resistors, etc., which should be connected to terminals likely to receive disturbance transients. Furthermore, the proper choice of mounting location and connection can improve immunity.

For 12 V systems, the maximum value of $U_s = -7$ V in test pulse 4 is normally only observed at the terminals of a solenoid-actuated starter-motor or, possibly, at the battery terminals of a field-coil-actuated starter-motor. Users are therefore advised to establish the type of starting system prior to designing their devices. In the interests of good immunity, it is recommended that electronic equipment not be connected to the terminals of the starter-motor.

B.3 Additional suppression techniques

Practical means of transient suppression may be obtained by one or more of the following methods:

- a) provision of a "clean" independent power supply for susceptible equipment;
- b) insertion of lumped suppression components at strategic points in the wiring harness;
- c) use of harness with low pass filter properties;
- d) careful routing of harnesses.

Annex C (normative)

Transient emissions evaluation — Voltage waveform

C.1 General

The purpose of this annex is to provide an evaluation method for characterizing transient emissions from disturbance sources as tested in accordance with 4.3.

C.2 Essential elements of transient emissions waveform characteristics

The waveform parameters listed, defined and abbreviated according to Table C.1, shall be taken into consideration for the evaluation of waveform characteristics.

Table C.1 — Waveform parameters

Parameter	Definition (see ISO 7637-1)	Abbreviation
Peak amplitude	3.12	$U_s (U_{s1}, U_{s2})$
Pulse duration	3.13.1	t_d
Pulse rise time	3.13.2	t_r
Pulse fall time	3.13.3	t_f
Pulse repetition time	3.14.4	t_1
Burst duration	3.14.1	t_4
Time between bursts	3.14.2	t_5
Burst cycle time	3.14.3	$t_4 + t_5$

C.3 Classification of transient emissions

C.3.1 General

The suggested minimum and maximum limits for transient emissions are given in columns I to IV of Tables C.2 and C.3, respectively. The acceptable limit at or between these values may be chosen by agreement between vehicle manufacturer and supplier. The transient may have to conform to either some or all of the parameters of Table C.1, depending on this agreement. In cases where no specific values are defined, it is recommended that levels selected from columns I to IV of Tables C.2 and C.3 be used.

Depending on the test set-up according to Figure 1 a) or 1 b), either slow pulses or transients will be observed. Both test set-ups shall therefore be used.

The voltage waveforms illustrated by Figures C.1 and C.2 are typical waveforms on the bench top according to the test conditions specified in 4.3. The application of the voltage emissions limit (U_s) are as follows.

C.3.2 Transient with both positive (U_{s2}) and negative pulses (U_{s1})

Both positive and negative voltage limits shall apply.

C.3.3 Transient with positive pulses (U_{s2})

Positive voltage limit shall apply.

C.3.4 Transient with negative pulses (U_{s1})

Negative voltage limit shall apply.

C.3.5 Transient with single or multiple bursts with positive (U_{s2}) or negative pulses (U_{s1})

The positive and/or negative voltage limit shall apply.

C.3.6 Typical transient waveforms

The essential parameters of single transient and bursts waveforms are illustrated by Figures C.1 and C.2.

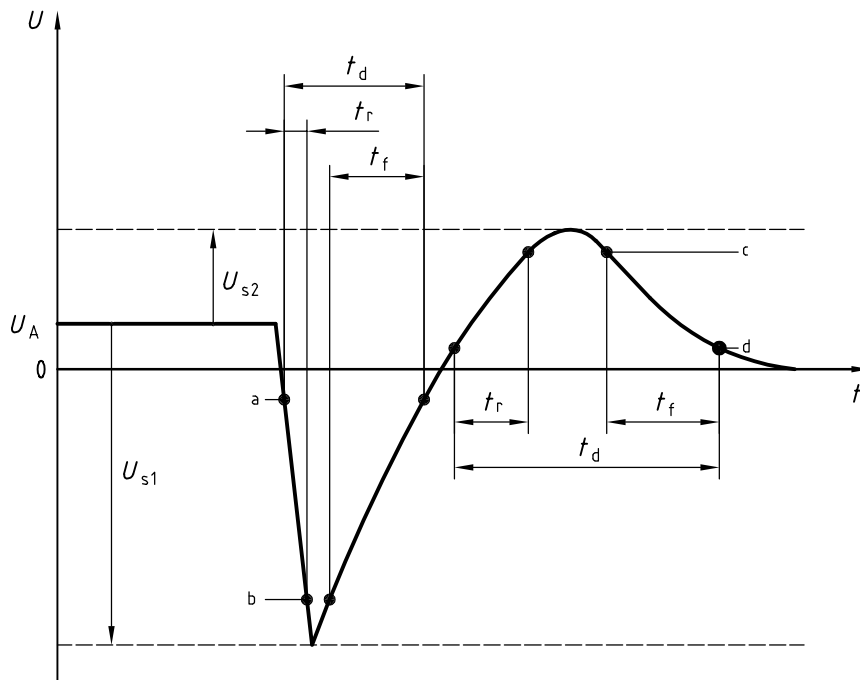

- a $0,1 (U_{s1} + U_A)$
- b $0,9 (U_{s1} + U_A)$
- c $0,9 (U_{s2} + U_A)$
- d $0,1 (U_{s2} + U_A)$

Figure C.1 — Single transient waveform

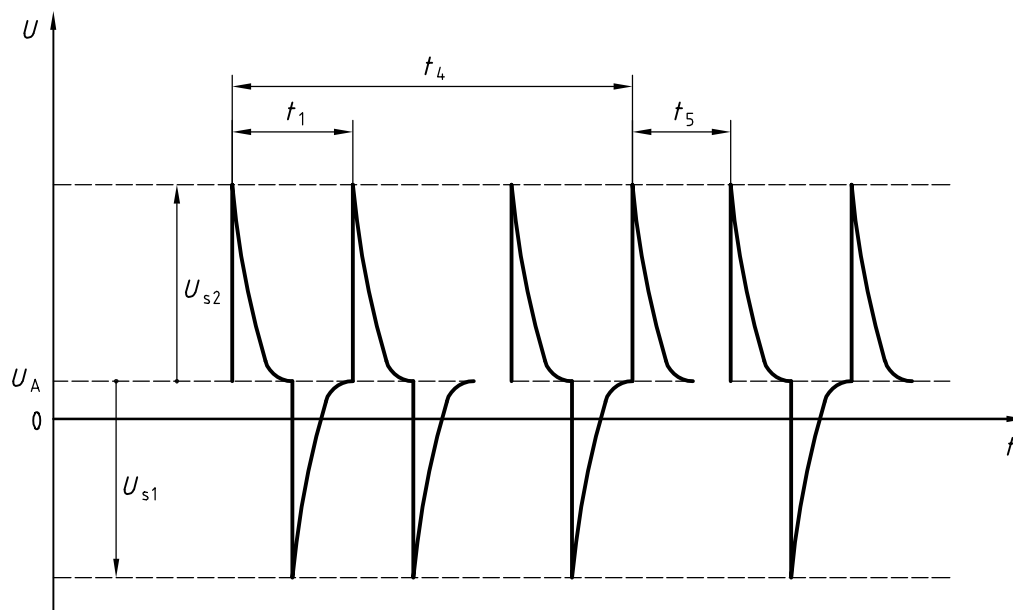

Figure C.2 — Burst transient waveform

C.3.7 Transient waveform classification table

To determine the transient amplitude and waveform, first measure using the test set-up shown in Figure 1 a) and determine the maximum amplitude of the slow pulses (millisecond range). Then use the test set-up shown in Figure 1 b) to determine the maximum amplitude for the transients (nanosecond range).

The classification of the transient amplitudes may be performed by applying the values given in Tables C.2 and C.3.

Table C.2 — Suggested limits for the classification of 12 V equipment

Pulse amplitude (U_s)	Suggested limit for U_s for severity level				
	V ^a	IV	III	II	I
Positive	—	+ 100 V	+ 75 V	+ 50 V	+ 25 V
Negative	—	- 150 V	- 100 V	- 50 V	- 25 V

^a Values to be determined by vehicle manufacturer and equipment supplier.

Table C.3 — Suggested limits for the classification of 24 V equipment

Pulse amplitude (U_s)	Suggested limit for U_s for severity level				
	V ^a	IV	III	II	I
Positive	—	+ 200 V	+ 150 V	+ 100 V	+ 50 V
Negative	—	- 600 V	- 450 V	- 300 V	- 150 V

^a Values to be determined by vehicle manufacturer and equipment supplier.

Annex D (normative)

Test pulse generator verification procedure

D.1 Scope

The purpose of this annex is to provide a method for the verification of the output characteristics of the test pulse generator.

D.2 General

See 5.5 for measurement instrumentation requirements.

The verification measurements given in D.3 shall be performed under two different loading conditions to determine the behaviour of the test pulse generator:

- a) under no load condition;
- b) under matched load conditions.

D.3 Pulse verification

The generator shall be verified to ensure conformance with the parameters given below for both open circuit and loaded conditions. The energy content may influence significantly the test results. Within the test report, the energy of the actual used pulses shall be listed (see Annex F for example methods for determining pulse energy).

The U_A and U_B for this verification procedure shall be 0 V.

Care shall be taken for the selection of the resistors. They shall have sufficient power dissipation for both pulse and d.c. supply rating. Additionally, they shall be non-inductive. The tolerance of the matching resistor shall be $\pm 1\%$.

The source impedance shall be selected such that it is equal to the load resistance defined for each test pulse.

D.3.1 Test pulse 1

See Tables D.1 and D.2.

Table D.1 — Test pulse 1 — 12 V system

Test pulse 1	U_s	t_r	t_d
No load	$-100 \text{ V} \pm 10 \text{ V}$	$\begin{pmatrix} 1 & 0 \\ - & 0,5 \end{pmatrix} \mu\text{s}$	$2\,000 \mu\text{s} \pm 400 \mu\text{s}$
10Ω load	$-50 \text{ V} \pm 10 \text{ V}$	—	$1\,500 \mu\text{s} \pm 300 \mu\text{s}$

Table D.2 — Test pulse 1 — 24 V system

Test pulse 1	U_s	t_r	t_d
No load	$- 600 \text{ V} \pm 60 \text{ V}$	$\begin{pmatrix} 3 & 0 \\ & -1,5 \end{pmatrix} \mu\text{s}$	$1\,000 \mu\text{s} \pm 200 \mu\text{s}$
50Ω load	$- 300 \text{ V} \pm 30 \text{ V}$	—	$1\,000 \mu\text{s} \pm 200 \mu\text{s}$

D.3.2 Test pulses 2a and 2b

See Tables D.3 and D.4.

Table D.3 — Test pulse 2a — 12 V and 24 V systems

Test pulse 2a	U_s	t_r	t_d
No load	$+ 50 \text{ V} \pm 5 \text{ V}$	$\begin{pmatrix} 1 & 0 \\ & -0,5 \end{pmatrix} \mu\text{s}$	$50 \mu\text{s} \pm 10 \mu\text{s}$
2Ω load	$+ 25 \text{ V} \pm 5 \text{ V}$	—	$12 \mu\text{s} \pm 2,4 \mu\text{s}$

Table D.4 — Test pulse 2b — 12 V and 24 V systems

Test pulse 2b	U_s	t_r	t_d
No load and $0,5 \Omega$ load	$+ 10 \text{ V} \pm 1 \text{ V}$ (12 V system) $+ 20 \text{ V} \pm 2 \text{ V}$ (24 V system)	$1 \text{ ms} \pm 0,5 \text{ ms}$	$2 \text{ s} \pm 0,4 \text{ s}$

D.3.3 Test pulses 3a and 3b

See Tables D.5 and D.6.

Table D.5 — Test pulse 3a — 12 V and 24 V systems

Test pulse 3a	U_s	t_r	t_d
No load	$- 200 \text{ V} \pm 20 \text{ V}$	$5 \text{ ns} \pm 1,5 \text{ ns}$	$150 \text{ ns} \pm 45 \text{ ns}$
50Ω load	$- 100 \text{ V} \pm 20 \text{ V}$	$5 \text{ ns} \pm 1,5 \text{ ns}$	$150 \text{ ns} \pm 45 \text{ ns}$

Table D.6 — Test pulse 3b — 12 V and 24 V systems

Test pulse 3b	U_s	t_r	t_d
No load	$+ 200 \text{ V} \pm 20 \text{ V}$	$5 \text{ ns} \pm 1,5 \text{ ns}$	$150 \text{ ns} \pm 45 \text{ ns}$
50Ω load	$+ 100 \text{ V} \pm 20 \text{ V}$	$5 \text{ ns} \pm 1,5 \text{ ns}$	$150 \text{ ns} \pm 45 \text{ ns}$

For verification of test pulses 3a/3b coaxial measuring devices shall be used. The spectrum of the pulses covers the frequency range up to 200 MHz. Within this range it is difficult to use high impedance voltage probes. The attached ground cable of the probe could cause significant ringing and result in false measurements. Coaxial measuring devices are therefore highly recommended.

D.3.4 Test pulse 4 — 12 V and 24 V system

No pulse verification is available.

D.3.5 Test pulse 5

See Tables D.7 and D.8.

Table D.7 — Test pulse 5 — 12 V system

Test pulse 5	U_s	t_r	t_d
No load	+ 100 V ± 10 V	$\left(10_{-5}^0\right)$ ms	400 ms ± 80 ms
2 Ω load	+ 50 V ± 10 V	—	200 ms ± 40 ms

The pulse is calibrated at a test level of 100 V, a pulse width of 400 ms and a source impedance of $R_i = 2 \Omega$ into a 2 Ω terminating resistor. A terminating resistor of 2 Ω is regarded an optimum (no influence of losses due to cables and connectors).

Table D.8 — Test pulse 5 — 24 V system

Test pulse 5	U_s	t_r	t_d
No load	+ 200 V ± 20 V	$\left(10_{-5}^0\right)$ ms	350 ms ± 70 ms
2 Ω load	+ 100 V ± 20 V	—	175 ms ± 35 ms

Annex E (informative)

Determination of pulse generator's energy capability

E.1 Determination and verification of pulse generator minimum energy capability

E.1.1 Calculation method

This method is used to calculate the energy of the pulse as delivered by the generator to the matching resistor (resistive load R_L), utilising the measured pulse parameters t_d and U_s .

The transient generator used shall generate double exponential transients, which are a result of capacitive discharges into a pulse shaping network. This type of generator is applicable to pulses 1 (12 V), 1 (24 V), 2a, 3a/3b and 5.

Pulses 2b and 4 must be realised by programmable d.c. power sources.

NOTE The influence of the rise time ($t_r \ll t_d$) is not taken into account, allowed for all pulses specified in this part of ISO 7637.

See Figures E.1 and E.2.

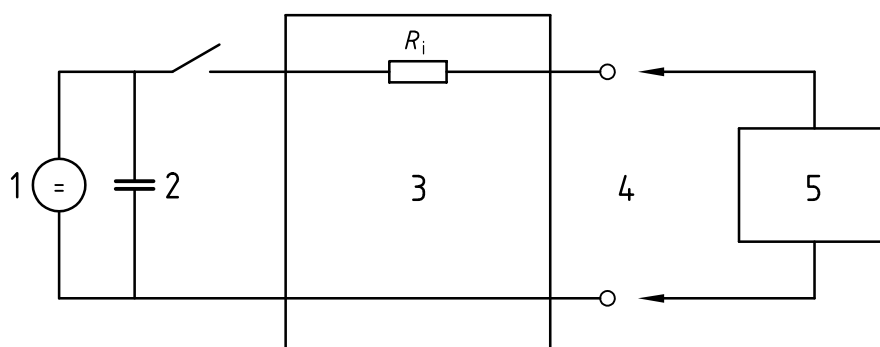

Key

- 1 power supply
- 2 capacitor C_s
- 3 pulse shaping network with internal resistance R_i
- 4 pulse output
- 5 matching load resistor R_L

Figure E.1 — Example of simplified circuit diagram of transient generator

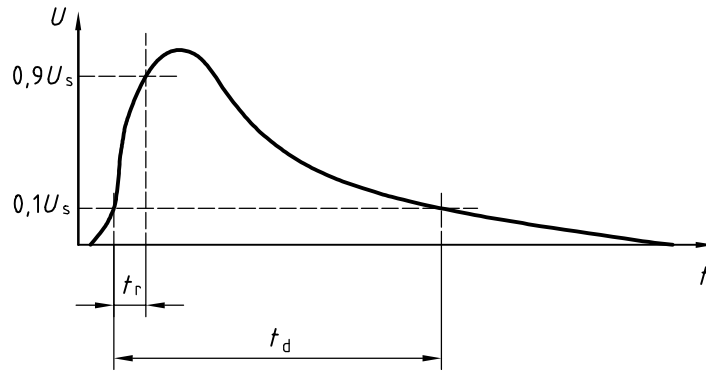

Figure E.2 — Double exponential pulse shape generated by a transient generator

a) Function of the voltage wave shape, $U(t)$ is calculated by:

$$U(t) = \frac{U_o \times R_L}{R_i + R_L} \times e^{-\left(\frac{2,3 \times t}{t_d}\right)}$$

where

U_o is the open circuit output voltage;

R_i is the source resistor of the generator;

R_L is the load resistor for the generator;

t_d is the pulse width $0,9U_s$ to $0,1U_s$;

b) Function of the current wave shape, $I(t)$, is calculated by:

$$I(t) = \frac{1}{R_L} \times \frac{U_o \times R_L}{R_i + R_L} \times e^{-\left(\frac{2,3 \times t}{t_d}\right)} = \frac{U_o}{R_i + R_L} \times e^{-\left(\frac{2,3 \times t}{t_d}\right)}$$

where

U_o is the open circuit output voltage;

R_i is the source resistor of the generator;

R_L is the load resistor for the generator;

t_d is the pulse width $0,9U_s$ to $0,1U_s$;

c) Function of the pulse energy, $P(t)$, is calculated by:

$$P(t) = U(t) \times I(t) = \frac{(U_o)^2 \times R_L}{(R_i + R_L)^2} \times \left(e^{-\left(\frac{2,3 \times t}{t_d}\right)} \right)^2 = \frac{(U_o)^2 \times R_L}{(R_i + R_L)^2} \times e^{-\left(\frac{4,6 \times t}{t_d}\right)}$$

where

U_o is the open circuit output voltage;

R_i is the source resistor of the generator;

- R_L is the load resistor for the generator;
 t_d is the pulse width $0,1U_s$ to $0,1U_s$;
 $I(t)$ is a function of the current wave shape;
 $U(t)$ is a function of the voltage wave shape.

d) Integral of $P(t)$ shows the energy content of a single pulse loaded with R_L :

$$W_e = \int_0^{\infty} P(t) dt = \frac{(U_o)^2 \times R_L}{(R_i + R_L)^2} \times \int_0^{\infty} e^{-\left(\frac{4,6 \times t}{t_d}\right)} dt$$

where

- U_o is the open circuit output voltage;
 R_i is the source resistor of the generator;
 R_L is the load resistor for the generator;
 t_d is the pulse width $0,1U_s$ to $0,1U_s$;
 W_e is the energy content of a single pulse.

e) This results in a short formula:

$$W_e = \frac{(U_o)^2 \times R_L}{(R_i + R_L)^2} \frac{t_d}{4,6}$$

$$W_e = \frac{(U_s)^2}{(R_L)} \frac{t_d}{4,6}$$

for $R_i = R_L$ the voltage $U_o = 2 U_s$; U_s is the peak voltage across R_L

where

- U_o is the open circuit output voltage;
 U_s is the peak voltage;
 R_i is the source resistor of the generator;
 R_L is the load resistor for the generator;
 t_d is the pulse width $0,1U_s$ to $0,1U_s$;
 W_e is the energy content of a single pulse.

E.1.2 Measurement method to determine generator's minimum energy capability

This method is for utilising the capability of the digital oscilloscope to determine the energy of the pulse as delivered by the generator to the matching resistor (resistive load R_L) once the pulse parameters t_d and U_s are measured.

EXAMPLE 1

Settings: CH 1 Voltage pulse across R_L using a voltage probe.
CH 1 — Choose the measurement function for energy. This measurement will typically be in the units of (V*V*s). Divide this value by the value of R_L in ohms. This result is the energy delivered into R_L .

EXAMPLE 2

Settings: CH 1 Voltage pulse across R_L using a voltage probe.
MATH1 Choose the waveform math function and multiply CH1*CH1.
Choose the measurement function for area. This measurement will be in the units of (V*V*s). Divide this value by the value of R_L in ohms. This result is the energy delivered into R_L .

EXAMPLE 3

Settings: CH 1 Voltage pulse at R_L using a voltage probe.
CH 2 Current pulse through R_L using a current probe.
CH A Multiplication of CH 1 and CH 2.
Measurement function: area (CH A).
This result is the energy delivered into R_L .

Annex F (informative)

Origin of transients in road vehicle electrical systems

F.1 General

The test pulses used in this part of ISO 7637 are based on pulses measured in vehicle electric systems under certain conditions and created by basic configurations in the electric circuits. In this annex, schematic diagrams are presented which show the origin of pulses 1 through 5. For the evaluation of emitted pulses, see Annex C.

F.2 Characteristic pulses

F.2.1 Pulse 1

The schematic circuit diagram that can produce pulse 1 is shown in Figure F.1.

Pulse 1 occurs due to supply disconnection from inductive loads. It influences devices which remain connected directly in parallel with this inductance. The pulse shape is represented in Figure 5.

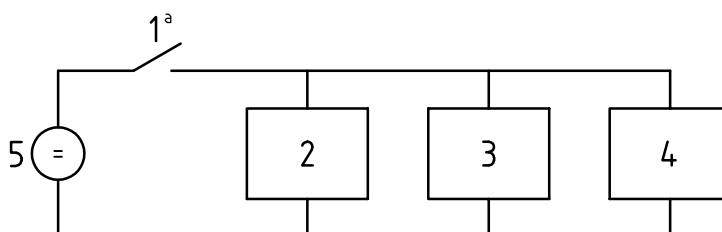

Key

- 1 ignition switch
- 2 inductive load
- 3 load R_s (see 4.2)
- 4 DUT
- 5 power supply

^a Pulse 1 occurs when the switch is opened.

Figure F.1 — Circuit diagram for pulse 1

F.2.2 Pulses 2a and 2b

See Figure F.2.

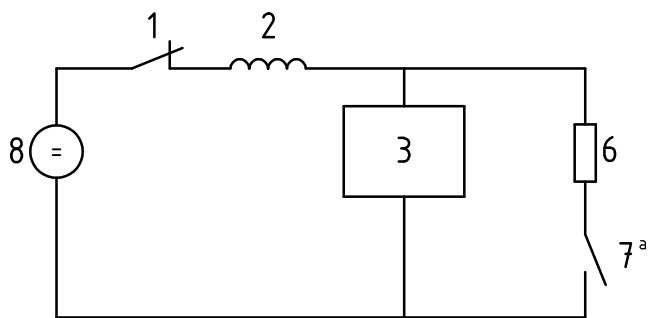

a) Pulse 2a

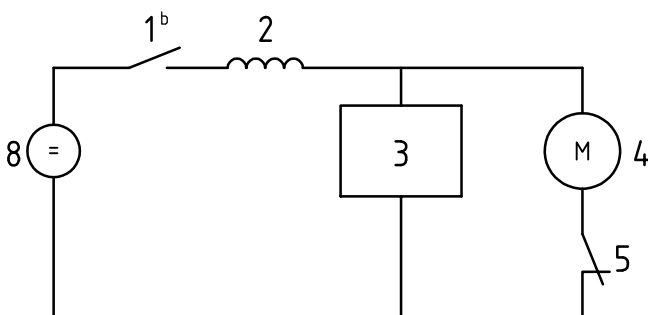

b) Pulse 2b

Key

- 1 ignition switch
- 2 wiring harness (inductive)
- 3 DUT
- 4 d.c. motor with internal inductance
- 5 motor switch
- 6 load
- 7 load switch
- 8 power supply

^a Pulse 2a occurs when the load switch (7) is opened while the ignition switch (1) is closed.

^b Pulse 2b occurs when the motor is running and the ignition switch (1) is opened.

NOTE The pulse shapes are represented in Figures 6 and 7.

Figure F.2 — Circuit diagrams for pulses 2a and 2b

F.2.3 Pulse 3

See Figure F.3. Pulse 3 occurs as the result of switching processes. The characteristics of this pulse are influenced by distributed capacitance and inductance of the wiring harness. The pulse shapes are represented by the combinations of pulses shown in Figures 8 and 9.

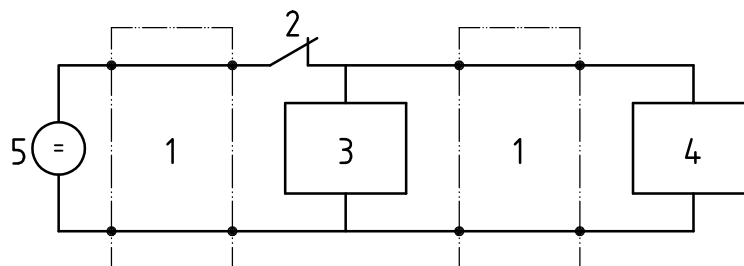

Key

- 1 wiring harness with distributed inductance and capacitance
- 2 switch
- 3 DUT
- 4 inductive load
- 5 power supply

Figure F.3 — Circuit diagram for pulse 3

F.2.4 Pulse 4

See Figure F.4. Pulse 4 is the voltage reduction caused by energising the starter motor circuits of internal combustion engines. The pulse shape is represented in Figure 10.

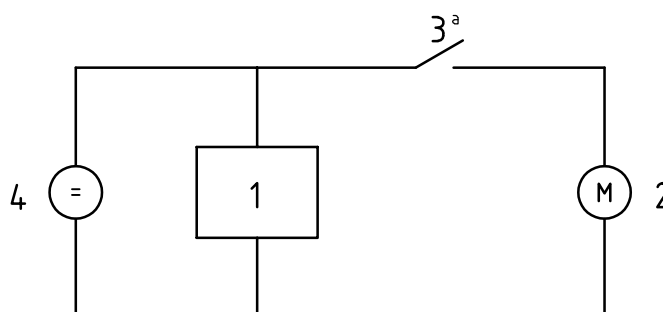

Key

- 1 DUT
- 2 starter motor
- 3 switch
- 4 power supply

^a Pulse 4 occurs when the starter motor is energised.

Figure F.4 — Circuit diagram for pulse 4

F.2.5 Pulse 5

See Figure F.5. Pulse 5 occurs in the event of a discharged battery disconnect while the alternator is generating charging current with other loads remaining on the alternator circuit at the moment of battery disconnect. The pulse shapes are represented in Figures 11 and 12.

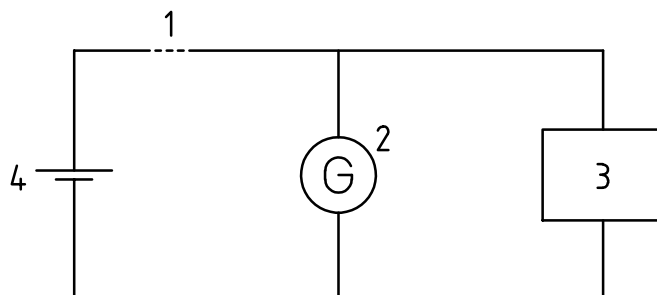

Key

- 1 defective connection
- 2 alternator
- 3 DUT
- 4 battery

Figure F.5 — Circuit diagram for pulse 5

